

**DOUBLE FLAP SYSTEMS
FOR NSHEV AND VENTILATION**

DOUBLE FLAP SYSTEMS FOR SMOKE AND HEAT EXHAUST VENTILATION (SHEV) AND ROOM AIR

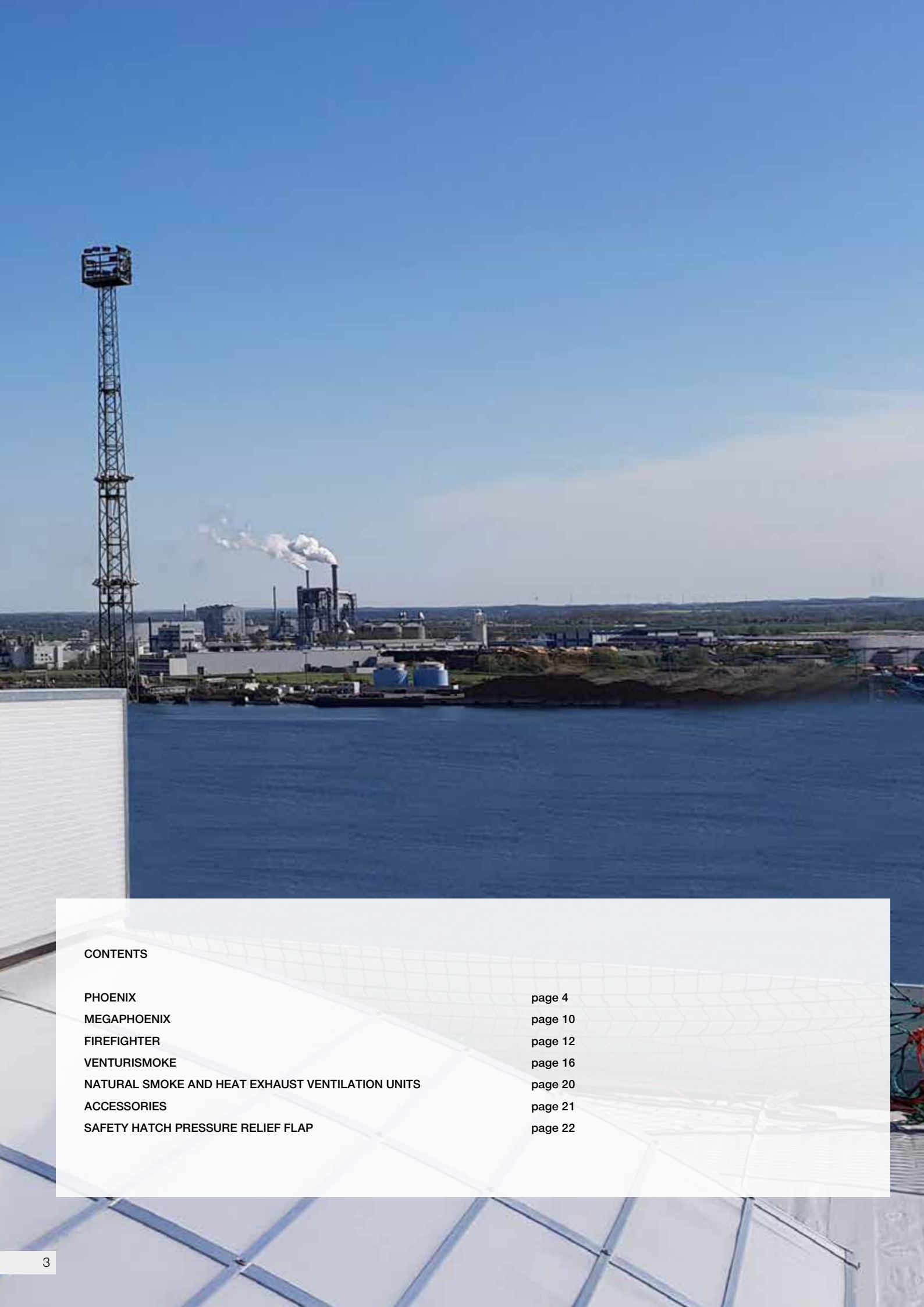



CONTENTS

PHOENIX	page 4
MEGAPHOENIX	page 10
FIREFIGHTER	page 12
VENTURISMOKE	page 16
NATURAL SMOKE AND HEAT EXHAUST VENTILATION UNITS	page 20
ACCESSORIES	page 21
SAFETY HATCH PRESSURE RELIEF FLAP	page 22

PHOENIX

The PHOENIX is the classic model in the roda product family: Proven durability, quality and stability. With a 90° airing position, the PHOENIX offers maximum ventilation and can also be used as an NSHEV. The device was designed to withstand extreme weather conditions. Upon customer request, we can adapt the PHOENIX to your individual requirements.

- Sound insulation values up to 33 dB can be achieved
- Natural, energy saving daylight illumination
- Glare-free when using PC Softlite or Lumira
- Good aerodynamic efficiency
- Good U values and low clearance losses
- Suitable for high snow and wind suction loads
- Efficient rainwater drainage via a central gutter
- Easy installation in all roof and wall constructions up to a slope of 90°

- Hoods open and close by compressed air from pneumatic cylinders with end position locking in both positions or by a 24 V linear drive
- Impermeability due to vulcanised EPDM profile seals
- Thermal separation is possible
- All hinges are made of cast aluminium parts combined with extruded aluminium profiles and stainless steel bearing bolts
- Drives connected via Teflon-coated bronze bushes (maintenance-free)
- Product is recyclable and comes without harmful materials
- 6° hood incline for optimal water drainage
- **Approved for: Flat roof, shed roof, gabled roof skylight and barrel skylight**

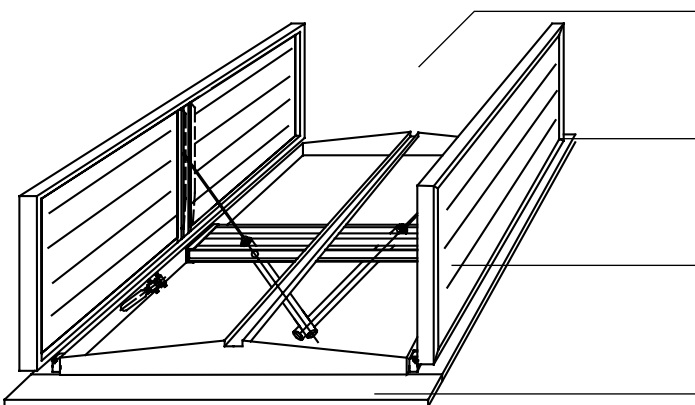

Ventilation area – the entire aerodynamically effective opening surface can also be used for ventilation.

Quality – designed for maximum service life both in terms of structure and material selection.

Energy efficiency – maximum efficiency, no mechanical support necessary for air exchange.

Dimensions – accurate and bespoke size adaptation to the supporting structure up to 7.5 m².



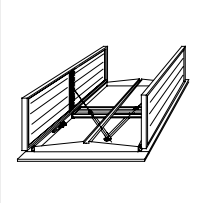

Double flap system PX2 variant

With our products we offer you real tailor-made solutions. The devices are available in all lengths and widths between 1000 x 500 mm and 2500 x 3000 mm.

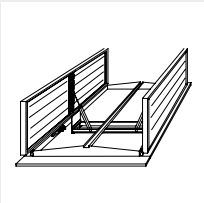

Double flap system with shortened cylinders PX2 MKII variant

Deviating from the standard version, the PHOENIX can also be designed with short cylinders. This variant is used when there is a risk that the cylinders could collide with the existing bottom fall-through protection grids, pipe-work or other objects on site. The PX2 MKII VARIANT is available in sizes between 1200 x 500 mm and 2000 x 2500 mm.

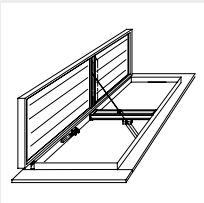

Single flap system PX1 variant

As a single flap system, the PHOENIX is optimised for gabled and shed roofs that allow such a design. It is available in sizes up to 1250 x 3000 mm.

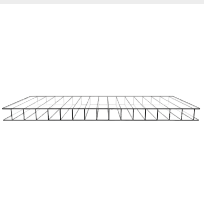

Glazing types

- 16 mm polycarbonate clear (with Lumira™ insulation on request), opal, opaque or Softlite
- 25 mm polycarbonate clear/opal (only for thermally separated hood)
- Single-ply aluminium
- Aluminium double-walled insulation
- Aluminium thermally separated with 20 or 30 mm insulation

Applications

The PHOENIX double flap system is suitable for almost all industrial applications. It can fully exploit the advantages of a double flap, especially in daily ventilation applications. The thermally separated variant reduces condensation and is therefore also suitable for use in high-humidity environments.





Special version with raised base.



K+S MINERALS AND AGRICULTURE GMBH

Project:

The saline air in the building reacts aggressively on the metals of the installed SHEV systems. Therefore, the existing rooflight domes were replaced with roda double flaps to prevent eroded parts from falling.

Systems:

- 16 roda PHOENIX double flaps with special duplex coating
- Pneumatic cylinder with hard chrome-plated piston rod and a protective cover over the manual release
- Piping made of an 8 mm thick, plastic-coated copper pipe

DAIMLER AG BERLIN BUILDING 40

Project:

During a roof renovation, the skylights, which had become dilapidated over the years, were to be replaced together with the integrated SHEV systems. It should also be possible to use the new elements for daily aeration and ventilation.

Systems:

- A total of 36 EUROLIGHT MKIII barrel skylights with integrated PHOENIX SHEV and ventilation systems (creating a total aerodynamically effective opening surface area of 421 m²)



MEGAPHOENIX

The MEGAPHOENIX is a multi-purpose ventilator. A PHOENIX serves as the base of the unit, which is then equipped with an adapted frame structure, which has longitudinal opening flaps. This enables a rainproof air exchange which is completely natural and weather-independent. This is because the longitudinal opening flaps open as soon as the top-side hoods close in the event of rain. This is a real plus, especially for operations that create a high level of humidity. For such applications, a permanent air exchange must be ensured, even in bad weather conditions. The release mechanism in the event of a fire is the same as that of the PHOENIX.

Like the double flap PHOENIX, the MEGAPHOENIX is suitable for almost all industrial applications. With the possibility of bad weather ventilation, the MEGAPHOENIX finds its use in those applications in which – in addition to the SHEV function – an increased volume of heat must be dissipated regardless of the weather.

- Bespoke adaptation to every building for roof openings up to 5.7 m²
- Good aerodynamic efficiency
- Suitable for high snow and wind suction loads
- Efficient rainwater drainage via central gutters
- All hinges are made of cast aluminium parts combined with extruded aluminium profiles and stainless steel bearing bolts
- Drives connected via Teflon-coated bronze bushes (maintenance-free)
- Easy installation in all roof constructions up to a slope of 90°
- Duct silencers optional
- Recyclable and comes without harmful materials
- **Approved for: Flat roof, shed roof, gabled roof skylight and barrel skylight**

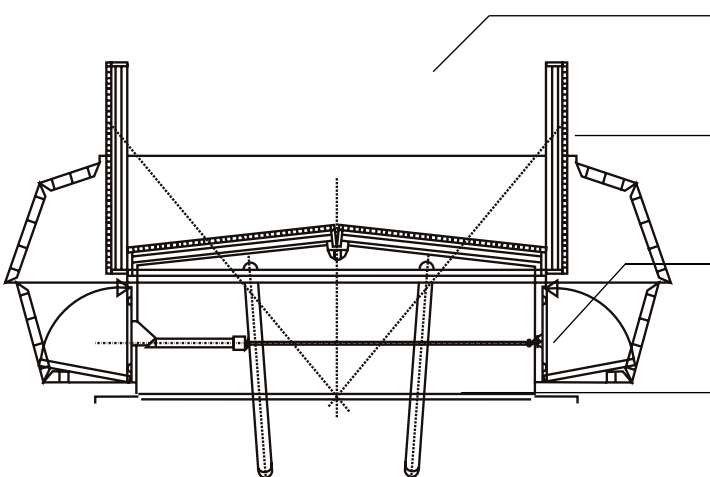

Ventilation area – the entire aerodynamically effective opening surface can also be used for ventilation.

Quality – designed for maximum service life both in terms of structure and material selection.

Ventilation in bad weather – rainproof ventilation via side flaps and side boxes.

Energy efficiency – maximum efficiency, permanent air exchange guaranteed.



STEINEL, LEIPZIG-MÖLKAU

Project:

The ventilation system in the production hall for hot-air devices has to process an enormous amount of waste heat from the injection moulding machines. Even when it rains, continuous ventilation must be guaranteed.

Systems:

- DELTALIGHT gabled roof skylight with MEGAPHOENIX multi-purpose ventilators spanning a length of almost 50 m
- Tenfold increase in the opening area to approximately 39 m²
- Rainproof ventilation thanks to the weatherproof side flaps of the MEGAPHOENIX



WANZL, LEIPHEIM

Project:

In this electroplating hall, only elements that can tolerate the corrosive vapours could be installed. We placed particular emphasis on this when renovating the roof.

Systems:

- 7 EUROLIGHT barrel skylights with opal PC multi-wall sheets
- 12 MEGAPHOENIX multi-purpose ventilators with fall-through protection grids
- 5 FIREFIGHTER DUO single flaps with PC multi-wall sheets with Lumira filling
- Special cylinders with hard-chrome plated piston rod, bellows and a protective sleeve over the locking mechanism
- KTL coating on all system parts

FIREFIGHTER

In addition to its use as a SHEV system, the FIREFIGHTER can be used for daily ventilation and is designed to withstand extreme weather conditions. A thermally separated version is also available which is perfectly suited for use in real glass constructions where high thermal or sound insulation values are required. This is possible because the frame and hood frame are made of extruded aluminium.

- High sound insulation values up to 56 dB are possible
- Good aerodynamic efficiency
- Good U values and low clearance losses
- Suitable for high snow and wind suction loads
- Efficient rainwater drainage via central gutters

- Hoods open and close by compressed air from pneumatic cylinders with end position locking in both positions or by a 24 V linear drive
- Waterproofing is achieved with vulcanised EPDM profile seals
- Optional thermal separation in accordance with DIN 4108
- All hinges are made of cast aluminium parts combined with extruded aluminium profiles and stainless steel bearing bolts
- Drives connected via Teflon-coated bronze bushes (maintenance-free)
- Recyclable and comes without harmful materials
- **Approved for: Flat roof, gabled roof, pitched roof, shed roof, gabled roof skylight, barrel skylight and pitched roof skylight**

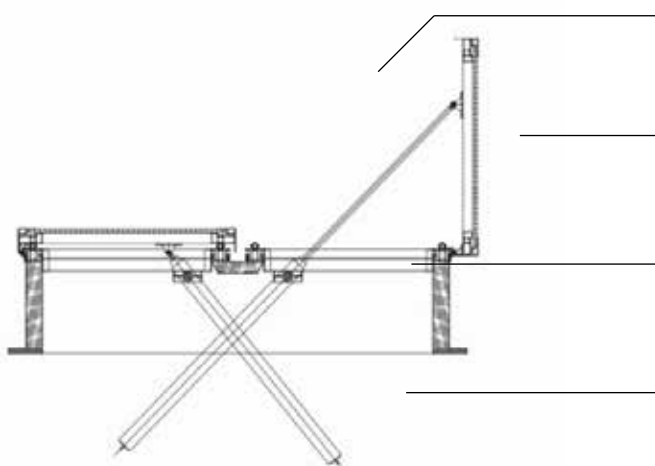

Ventilation area – the entire aerodynamically effective opening surface can also be used for ventilation.

Field of application – perfectly suited for glass constructions and showpiece architecture.

Energy efficiency – maximum efficiency, as no mechanical support is necessary for air exchange.

Dimensions – accurate and bespoke size adaptation to the supporting structure up to 4.75 m².



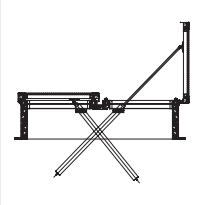

FIREFIGHTER DUO double flap system

With our products we offer you real tailor-made solutions. The devices are available in all lengths and widths from 1000 x 1000 mm up to 1900 x 2500 mm.

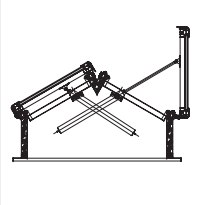

FIREFIGHTER DELTA double flap system

The FIREFIGHTER DELTA is inherently thermally separated. It offers optimal water drainage thanks to the incline of its flaps. It is available in sizes from 1000 x 1000 mm up to 1500 x 2500 mm.

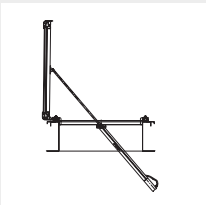

FIREFIGHTER MONO single flap system

As a single flap system, the FIREFIGHTER MONO is optimised for gabled and shed roofs that allow such a design. It is available in sizes from 500 x 1000 mm up to 950 x 2500 mm.

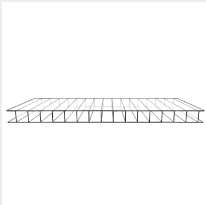

Glazing types

- PC 16 mm polycarbonate clear (with Lumira™ insulation on request), opal, opaque or Softlite
- Different laminated safety glass and other types of glass available on request (fire protection class A1)
- Double-walled aluminium 50 mm or 70 mm insulated (thermally separated)
- Aluminium/steel/aluminium multi-wall combination with 70 mm insulation for soundproofing
- Glazing up to PC 32 mm polycarbonate in various designs possible

Applications

Because the FIREFIGHTER can also be filled with glass, it is suitable for use in public buildings where people are supposed to enjoy a clear view of the sky. The fact that insulating glass has a significantly lower noise level when it rains can also be seen as a strong argument for picking the FIREFIGHTER. The high sound insulation values of the system also make it suitable for special applications such as in theatres or cinemas.



COLLEGE, FURTWANGEN

Project:

Several glass roof structures on a green and partially gravelled roof over corridors and staircases were equipped with ventilation and SHEV elements.

Systems:

- 13 FIREFIGHTER double flap systems insulated with SHEV boxes, network box and control panel
- 4 FIREFIGHTER single flap systems in the staircase as lighting units for ventilation, daylight and SHEV functions



BERLIN STATE OPERA UNTER DEN LINDEN

Project:

For the auditorium and the stage tower, the Berlin Senate Administration demanded the highest possible sound insulation value to prevent acoustic influences from outside. The Firefighters were clad with copper sheets to match the roof design to avoid standing out in accordance with the requirements for protect the monument.

Systems:

- 10 FIREFIGHTER with an overall sound insulation value of 54 dB

VENTURISMOKE

VS1 AND VS2

The VenturiSmoke VS2 is an EN-approved, natural smoke and heat exhaust ventilation unit. The primary USP of the VenturiSmoke VS2 is its geometric opening area of up to ten square metres, enabling the system to realise an aerodynamically effective opening surface of 6.7 m². Despite its size, the double flap works with one cylinder or linear drive per hood. The VenturiSmoke can be designed as double flap (VS2) or single flap (VS1) system. The VS2 opens with an opening angle of 90° in the event of a fire as well as for daily ventilation.

- Aerodynamically effective opening surface up to 6.7 m²
- Natural, energy saving daylight illumination which is glare-free when using PC Softlite or Lumira
- U values below 1 W/m²K available
- Suitable for high snow and wind suction loads
- Efficient rainwater drainage via a central gutter
- Comes completely pre-assembled or supplied in modules
- Unit with vulcanised EPDM seals completely silicone-free
- Depending on the version, the hoods open and close using compressed air cylinders with end position locking in both positions or electrically operated actuators
- All hinges are made of cast aluminium parts combined with extruded aluminium profiles and stainless steel bearing bolts
- Drives connected via Teflon-coated bronze bushes (maintenance-free)
- System can be fully assembled before bonding into the roof membrane
- Recyclable and comes without harmful materials
- Base is tested and certified as part of the system
- **Approved for flat roofs**

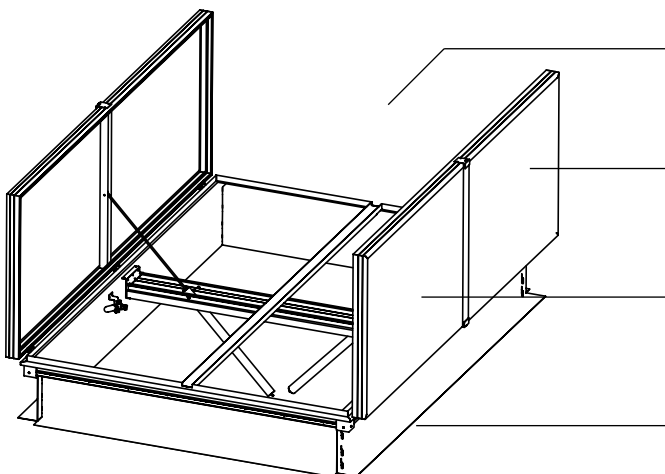

Ventilation area – the entire aerodynamically effective opening surface can also be used for ventilation.

Quality – designed for maximum service life both in terms of structure and material selection.

Energy efficiency – maximum efficiency, no mechanical support necessary for air exchange.

Dimensions – accurate and bespoke size adaptation to the supporting structure up to 10 m².



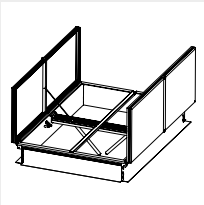

VenturiSmoke V2 double flap system

With our products we offer you real tailor-made solutions. The devices are available in all lengths and widths between 1000 x 500 mm and 2500 x 3500 mm.

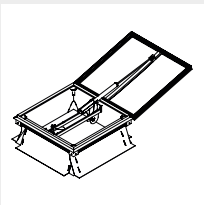

VenturiSmoke V1 single flap system

Single flap system and smoke and heat exhaust ventilation unit approved according to EN standards. Ideal for flat roof applications with flexible sizes up to a roof opening size of 2000 x 2000 mm. Fixed construction widths in the following sizes: 1000, 1200, 1250, 1400, 1500, 1800 and 2000 mm. Variable construction length from 1000 - 2000 mm. The opening angle in the event of a fire is 165°. For daily ventilation, the pneumatic version can be optionally equipped with a 230 V electric drive, which opens with a stroke of 300 mm. With the 48 V version, the drive can also be used for ventilation purposes.

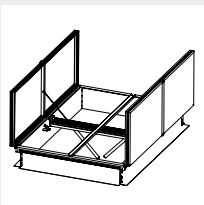

Base

The base of the VenturiSmoke is part of the system and is therefore tested as such. The single-shell base is made of AlMgSi05 aluminium and consists of a narrow frame with a rain gutter. EPDM seals reduce the outflow of warm air to a minimum. The bearing points on the drives consist of Teflon-coated bronze bushes and are maintenance-free.

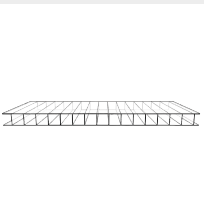

Glazing types

- PC 16 mm polycarbonate clear (with Lumira™ insulation on request), opal, opaque or Softlite
- PC 16 or 25 mm polycarbonate clear/opal
- PC 16 + PC 40 mm polycarbonate clear/opal (U value for the overall system is under 1 W/m²K)
- Single-ply aluminium
- Aluminium double-walled insulation
- Aluminium thermally separated with 20 or 30 mm insulation

Applications

The VenturiSmoke VS1 is the perfect system if only a SHEV function is required or a minimal ventilation capacity (via a 300 mm hood) is sufficient, but the system's durability must meet the highest demands.



JYSK, BULGARIA

Project:

New construction of two high-bay warehouses with roofs at a height of 42 m. The greatest challenge here was the wind suction loads, as wind speeds usually reach up to 120 km/h. Therefore roda was awarded the contract because the single flap VenturiSmoke VS1 is tested for wind suction loads up to WL4500. roda supplied and installed the single flaps as well as the complete control system including the compressors.

Systems:

- 196 VenturiSmoke VS1 single flaps with a total geometric opening surface of 313 m² / aerodynamically effective opening surface of 194 m²
- Aluminium frame profiles with a construction depth of 100 mm for the required stability of the hoods
- Hinges designed for durability in daily ventilation applications and end position locking cylinders
- Own compressed air system with several compressors to supply the pneumatically operated hoods







NATURAL SMOKE AND HEAT EXHAUST VENTILATION UNITS

Our roda smoke lifts meet legal requirements and official standards for fast and efficient smoke and heat exhaust ventilation (SHEV). But we also meet the demands of building owners, because they can rely on our pneumatic or electric solutions which are economical and precisely tailored to their needs.

The natural smoke and heat exhaust ventilators (NSHEVs) offer the highest degree of individuality with absolute dimensional accuracy. With our wide range of accessories, we can customise our units to meet your individual requirements and wishes, as well as match the building. And we keep one thing in mind above all else: The utmost safety and reliability of our NSHEVs in the event of fire.

Temperature parameters according to DIN EN 12101-2 and test results

Our NSHEVs reliably open into the SHEV position in less than 60 seconds...

	...and ensure high smoke discharge volumes	Flow rate coefficient C_v between 0.4 and 0.65 Aerodynamically effective opening area A_w between 0.325 m ² and 6.7 m ²
	...after endurance test – 1,000 times in SHEV position and 10,000 times in ventilation position	RE 1000 Ventilation 10,000
	...under snow load	SL 300 to SL 9040
	...down to indoor temperature of -15 °C	T (-5), T (-10) and T (-15)
	...after exposure to wind suction	WL 750 to WL 4500
	...when exposed to fire	B300

How you benefit

- Tested to DIN EN 12101-2
- For double flap systems, the full ventilation area is available when in ventilation mode with an opening of 90°

- CO₂ cartridges in the NSHEV are not damaged during manual triggering and maintenance
- Complies with DIN 18234 without extra costs or work
- Our double flap systems can be used for daily ventilation



Fall-through protection grid

- Approved fall-through protection according to GS-Bau 18
- No reduction in the aerodynamically effective smoke ventilation area



Insect and bird protection grid

- Optimal protection for hygienic operations
- Made of durable material which is easy to clean
- Easy access, also available as a drawer
- Tested for aerodynamic influence



Electric drive

- Available as a 24 V version
- Electric linear drive
- Suitable for daily ventilation



Pneumatic drive

- End locking in open and closed positions
- Tested for explosion protection (ATEX) (only PHOENIX/MEGAPHOENIX)
- Suitable for daily ventilation

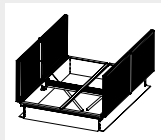

Night flap

- For halls where skylights are not required

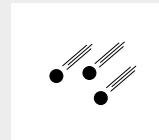

Hail protection

- Composite glazing with hail protection class HR5 available



Wind and rain sensors

- For automatic closing in wind and rain
- Operated as a group and individually

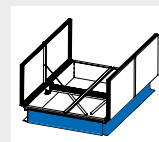

Paint coating in RAL

- Customised powder coating for special requirements



Timer for night cooling

- For energy efficient air conditioning of buildings

Base

- PHOENIX/MEGAPHOENIX: Made of AlMg3 aluminium
- FIREFIGHTER: Frame and hood frames made of AlMgSi05F22
- Thermal separation is possible
- Waterproofing with vulcanised EPDM profile seals
- Fastening with tension locks or screw connections + sealing washer

SAFETY HATCH

The Safety Hatch pressure relief flap is used to compensate for a sudden pressure increase caused by rapidly expanding gases, such as those produced by deflagration. The release mechanism is activated by a bolt plate whose predetermined breaking point breaks at a defined static pressure and allows the hoods to open. A laterally mounted spring with a steel cable prevents the pressure wave from causing the hoods to hit the roof uncontrolledly. The base for the Safety Hatch is the PHOENIX NSHEV, which has been modified accordingly for this application.

- Sound insulation values up to 28 dB can be achieved
- The use of bolt plates as a release mechanism allows for cost-effective reuse of the systems after a release
- All unit sizes
- Bolt plates manufactured according to the size of the specified value for the release torque
- A retention mechanism prevents damage to the roof and hoods in the event of a release
- Good thermal insulation value thanks to standard 20 mm insulation of the aluminium hoods with rock wool (thicker insulation is also possible if required) and 30 mm insulation of the base including the rain gutter
- Available as a single or double flap system
- As the Safety Hatch resembles the PHOENIX NSHEV, the systems can be used in combination without the visual appearance of a variety of systems in use
- Low-maintenance construction
- The systems meet the requirements of Directive 2006/42/EC on Machinery



Mounting points for the bolt plate



Release at a defined pressure

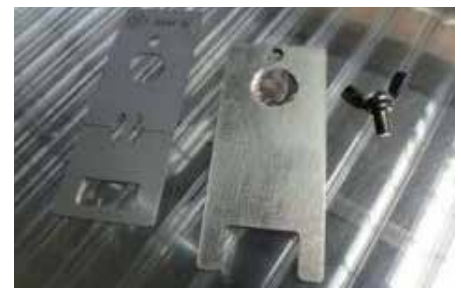

Bolt plate with engraved characteristic value





Scan this to discover more about
roda systems!



PHOENIX AND MEGAPHOENIX



FIREFIGHTER



VENTURISMOKE VS1/VS2

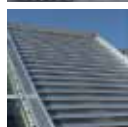

SMOKEJET AND MULTIJET



SMOKE CURTAINS



LOUVER WINDOWS



DAYLIGHT TECHNOLOGY



NATURAL AND MECHANICAL
VENTILATION



SMOKE AND HEAT
EXHAUST VENTILATION



RENOVATION



MIROTEC GLASS AND
METAL CONSTRUCTIONS



LAMILUX DAYLIGHT SYSTEMS

The technical data listed in this brochure correspond to the current status at the time of printing and are subject to change. Our technical data refer to calculations, supplier information or have been determined by an independent testing institute in the course of a test in accordance with the applicable standards. The heat transfer coefficients for our plastic glazing were calculated using the "method of the finite elements" with reference values according to DIN EN 673 for insulating glass. In doing so, the temperature difference of 15 K between the outer surfaces of the material was defined, taking into account practical experience and the specific characteristics of the plastic. The functional values refer only to test pieces in the dimensions intended for the test. No further guarantee for technical values is given. This applies in particular to changed installation situations or if subsequent measurements are made on the building site.



E.M.B. Products GmbH

Rudolf-Diesel-Straße 6 | 46446 Emmerich am Rhein

Phone: +49 2822 69762

contact@emb-products.de | www.roda.de

